

YAMAHA

POWER AMPLIFIER

P4500

P3200

P1600

Owner's Manual

Mode d'emploi

Bedienungsanleitung

Manual de instrucciones

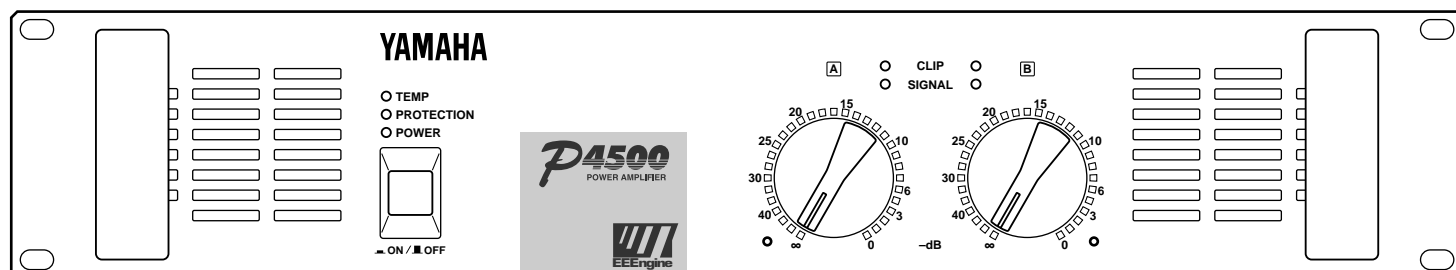

Introduction

Thank you for purchasing a Yamaha P4500/3200/1600 series power amplifier.

This series of audio amps was developed from Yamaha's wealth of experience in building PA equipment and its tradition of careful attention to every detail of circuit design. These amps feature high power and superb quality together with superior reliability and stability, guaranteeing the highest possible audio performance.

Main features of the P4500/P3200/P1600 series

- Three types of input jack (balanced XLR type connectors, balanced phone jacks, and barrier strip), and five-way binding post output jacks are provided, allowing use in a wide variety of situations including installed applications.
- Three operating modes are provided: STEREO mode in which CHANNEL A and B operate independently, PARALLEL mode in which a mono source is output by two amp systems, and BRIDGE mode in which the unit operates as a single high-power amplifier.
- A SIGNAL indicator and CLIP indicator is provided for each channel.
- The PROTECTION indicator shows the status of protective circuitry such as power-on/off protection, output muting, and the DC detection circuit. The TEMP indicator warns of heat sink overheating.
- Variable-speed low-noise fan(s) ensures high reliability even under demanding conditions.

This owner's manual covers the three models P4500, P3200 and P1600. In order to take full advantage of your power amp and enjoy long and trouble-free operation, please read this owner's manual carefully before use.

IMPORTANT NOTICE FOR THE UNITED KINGDOM

Connecting the Plug and Cord

WARNING: THIS APPARATUS MUST BE EARTHED

IMPORTANT: The wires in this mains lead are coloured in accordance with the following code:

GREEN-AND-YELLOW	: EARTH
BLUE	: NEUTRAL
BROWN	: LIVE

As the colours of the wires in the mains lead of this apparatus may not correspond with the coloured markings identifying the terminals in your plug, proceed as follows:

The wire which is coloured GREEN and YELLOW must be connected to the terminal in the plug which is marked by the letter E or by the safety earth symbol or coloured GREEN and YELLOW.

The wire which is coloured BLUE must be connected to the terminal which is marked with the letter N or coloured BLACK.

The wire which is coloured BROWN must be connected to the terminal which is marked with the letter L or coloured RED.

* This applies only to products distributed by YAMAHA KEMBLE MUSIC (U.K.) LTD.

Precautions

- 1. Avoid excessive heat, humidity, dust and vibration.**
Keep the unit away from locations where it is likely to be exposed to high temperatures or humidity — such as near radiators, stoves, etc. Also avoid locations which are subject to excessive dust accumulation or vibration which could cause mechanical damage.
- 2. Ventilation**
Allow a distance of 10 cm between the unit and the wall so that heat generated from the unit will be released effectively. Also, allow enough space between the unit and other devices. If you mount the unit in an audio rack, keep a space of 10 cm on the top panel, and a space of 1 cm to the side panel. Remove the rear panel of the rack or open a vent hole. If heat release is inadequate, the unit will retain heat inside the unit, which may cause a fire.
- 3. Avoid physical shocks.**
Strong physical shocks to the unit can cause damage. Handle it with care.
- 4. Do not open the case or attempt repairs or modifications yourself.**
This product contains no user-serviceable parts. Refer all maintenance to qualified Yamaha service personnel. Opening the case and/or tampering with the internal circuitry will void the warranty.
- 5. Make sure power is off before making or removing connections.**
Always turn the power OFF prior to connecting or disconnecting cables. This is important to prevent damage to the unit itself as well as other connected equipment.
- 6. Handle cables carefully.**
Always plug and unplug cables — including the AC cord — by gripping the connector, not the cord.
- 7. Clean with a soft dry cloth.**
Never use solvents such as benzine or thinner to clean the unit. Wipe clean with a soft, dry cloth.
- 8. Always use the correct power supply.**
Make sure that the power supply voltage specified on the rear panel matches your local AC mains supply. Also make sure that the AC mains supply can deliver more than enough current to handle all equipment used in your system.

Contents

Controls and Functions	2
Front Panel	2
Rear Panel	3
Modes: STEREO/PARALLEL/BRIDGE	4
SPEAKER IMPEDANCE	4
Caution for Speaker Connection	5
Rack Mounting	6
Mounting in an EIA standard rack	6
Mounting four or fewer amps in an open-backed rack	6
Mounting five or more amps, or when (even with four or fewer units) the back of the rack cannot be left open	6
Portable Rack Mounting	7
Positioning the Housed Amplifier	7
Specifications	8
General Specifications	8
Block Diagram	9
Dimensions	9
Performance Graphs	10
Troubleshooting	10

Controls and Functions

■ Front Panel

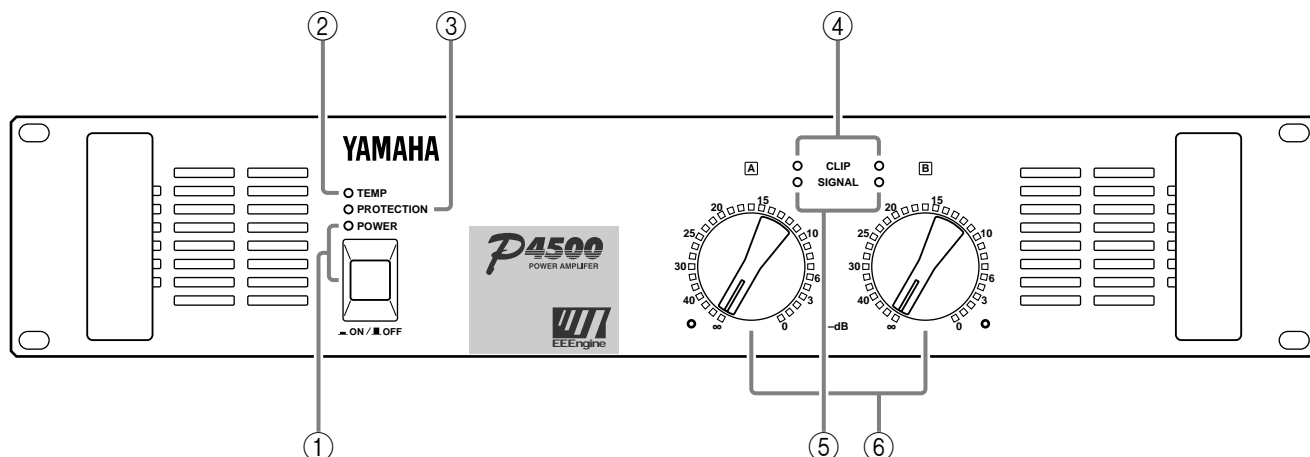

① POWER switch and indicator

This is the main POWER switch. Press to power ON the amplifier. Press again to power OFF. The POWER indicator lights up when the amplifier is powered ON.

② TEMP indicator

When the temperature of the heat sink exceeds 85 degrees Celsius, this indicator will light red.

③ PROTECTION indicator

This red LED indicator lights up for approximately 3 seconds when the amplifier is powered ON, indicating that the soft-start protection system is working. No sound is output during soft-start up. If one of the protection systems is activated during normal use, this indicator lights up and no sound is output. The speaker system is actually disconnected from the amplifier outputs when this indicator lights up. The protection systems are activated when overheating occurs or a DC voltage is present at the amplifier outputs. If the problem is corrected, the protection systems deactivate automatically, this indicator goes out, and normal amplifier operation is resumed.

④ CLIP indicators

These red LED indicators light up when the respective channel's output signal distortion exceeds 1% (i.e. clipping). Output signal clipping is usually due to excessive input signal levels.

⑤ SIGNAL indicators

These green LED indicators light up when the respective channel's output signal exceeds 2 Vrms. This is equivalent to 1/2 watt into 8Ω, 1 W into 4Ω.

⑥ Volume controls

These volume controls allow you to adjust the volume level in 31 steps in the range between $-\infty$ dB and 0 dB. To fix the volume setting by protecting the controls, install the included security cover over the controls and tighten the screws in the holes as shown below.

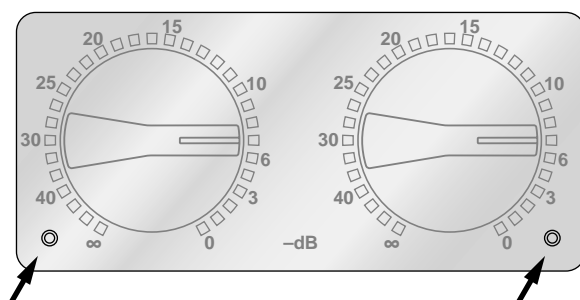

■ Rear Panel

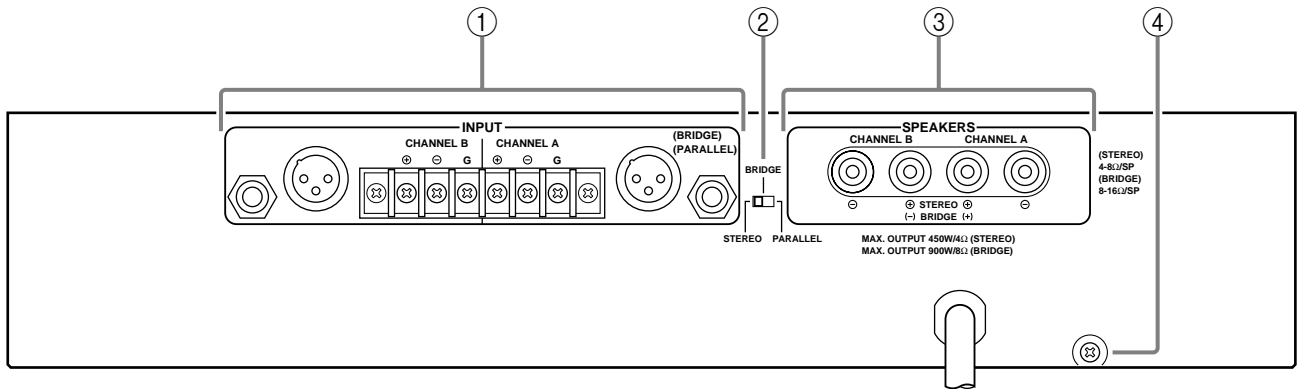

① INPUT terminals (CHANNEL A, B)

Three types of balanced terminals for channels A and B are provided.

Channel A input terminal is used in Bridge and Parallel mode.

• XLR-3-31 type connector

They are wired pin 1–ground, pin 2–hot (+), and pin 3 cold (–).

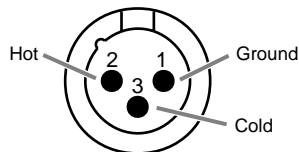

• Phone jack

They are wired tip–hot (+), ring–cold (–), and sleeve–ground.

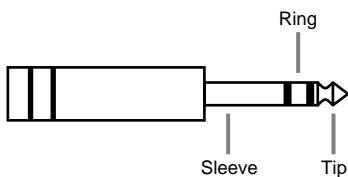

• Barrier strip

Hot (+), Cold (–) and Ground (G).

② STEREO/BRIDGE/PARALLEL switch

This slide switch is used to set the amplifier operating mode: STEREO, BRIDGE or PARALLEL.

For details on the functionality of each mode, refer to “Modes” on page 4.

③ SPEAKERS terminals

For polarity in each mode, refer to the following diagram.

• STEREO, PARALLEL mode

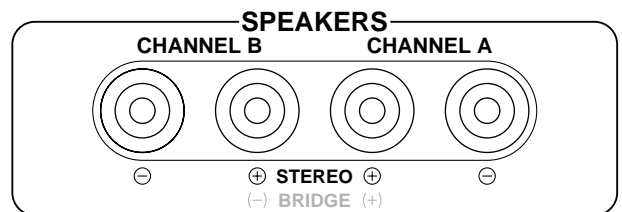

• BRIDGE mode

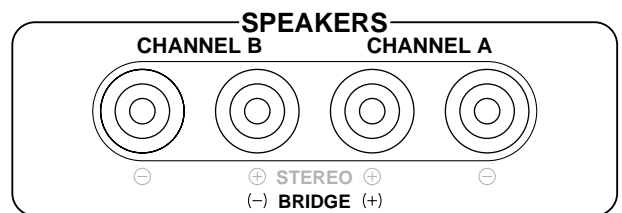

In BRIDGE mode, the (–) jacks of CHANNELS A and B are not used.

The minimum impedance for the connected speaker system is specified in “Speaker Impedance” on page 4.

④ GND terminals

This is the grounding screw terminal. If hum or noise occurs, ground (earth) the unit via this jack, or try connecting it to the chassis of the mixer or preamp, etc.

■ Modes: STEREO/PARALLEL/BRIDGE

STEREO mode

In this mode, channels A and B operate independently (as a conventional stereo amp).

The CHANNEL A input signal will be output from the CHANNEL A output jacks, and the CHANNEL B input signal will be output from the CHANNEL B output jacks.

PARALLEL mode

In this mode, the CHANNEL A input signal will be output from the output jacks of both channels A and B. The CHANNEL B input jack is not used. The (channel)

[A] and [B] volumes can be adjusted independently.

BRIDGE mode

In this mode, the CHANNEL A input signal will be output from the BRIDGE output jacks. In this case, use the front panel (channel) [A] volume control to adjust the volume.

■ SPEAKER IMPEDANCE

In STEREO and PARALLEL modes, the minimum load (=speaker) impedance is 4Ω. In BRIDGE mode it is 8Ω. Make sure that the impedance does not fall below this specified impedance.

STEREO mode connections

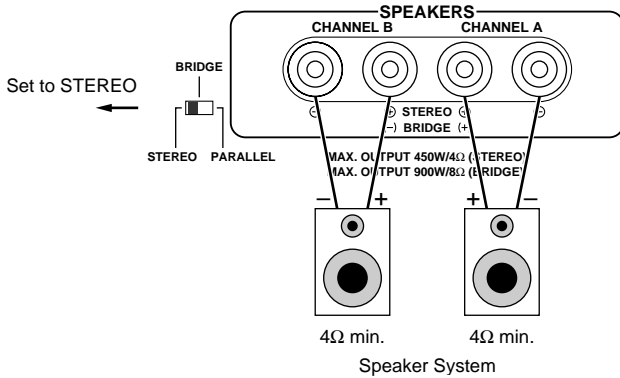

BRIDGE mode connections

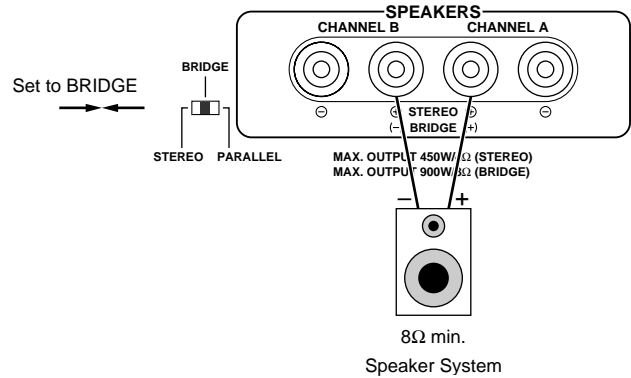

PARALLEL mode connections

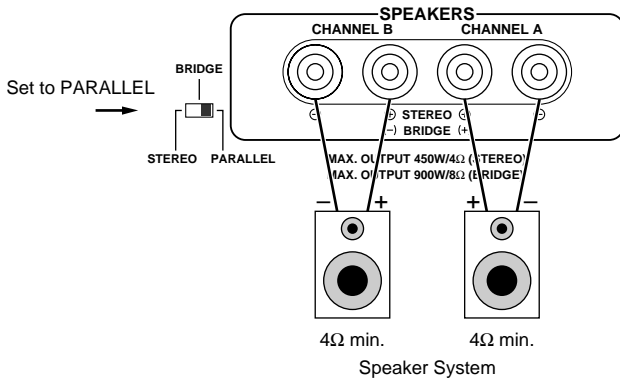

Caution for Speaker Connection

1. Turn off the POWER switch.
2. Remove the cover attachment screw(s) and remove the protective cover from the speaker terminals.



3. After removing approx. 10 mm of insulation from the ends of the speaker cables, pass the bare ends of the speaker wires through the holes in the corresponding speaker terminals and tighten the terminals to securely clamp the wires.
Refer to page 3 for speaker polarity.

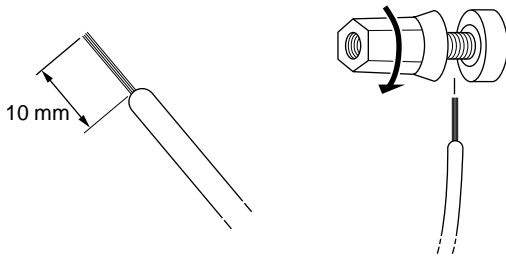

At this time make sure that the bare ends of the speaker cables do not extend from the terminals in such a way that they touch the chassis.

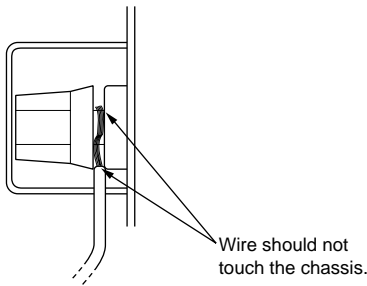

4. Reattach the protective cover over the speaker terminals.

- **Speaker fuse**

The output capacity of your amplifier is very high: 460 W+460 W (8Ω) in stereo and 1240 W (8Ω) in monaural on the P4500; 340 W+340 W (8Ω) in stereo and 880 W (8Ω) in monaural on the P3200; 160 W+160 W (8Ω) in stereo and 400 W (8Ω) in monaural on the P1600. Be sure to use a speaker system that has sufficient input capacity.

If the input capacity of your speaker system is lower than the rated output of the power amplifier, you can protect your speakers by connecting a fuse serially between the speaker and amplifier as shown below.

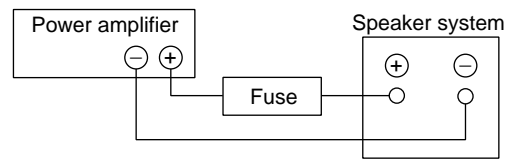

Use the following formula to determine the fuse capacity according to the speaker's input capacity.

$$P_0 = I^2 R \rightarrow I = \sqrt{P_0/R}$$

P_0 [W] : Speaker's continuous input capacity (noise or RMS)

R [Ω] : Speaker's nominal impedance

I [A] : Required fuse capacity

ex.) Speaker's continuous input capacity : 100 W
Speaker's impedance : 8Ω

$$I = \sqrt{100/8}$$

In this example, the required fuse capacity is calculated as 3.5 [A].

- **Speaker cable**

If you use a long speaker cable, use as thick a cable as possible to prevent deterioration of the damping factor or power loss inside the cable.

Rack Mounting

■ Mounting in an EIA standard rack

If multiple high-power amp units are mounted in a rack with poor ventilation, the heat from the amps will cause the interior of the amp to become very hot, causing the performance of the amps to be impaired. When mounting amps in a rack, you must make provision for ventilation so that the heat can escape.

When mounting amps in a rack, please attach ventilation panels above and below the amp to allow air circulation. When doing so, it is necessary for 35% or more of the entire surface area of a 1U size panel to be open.

Air circulation will be even better if the top surface of the rack has ventilation openings.

Ventilation panel

Yamaha provides an optional 1U-size ventilation panel VP1.

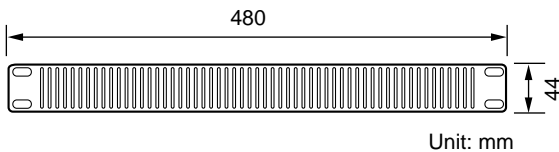

■ Mounting four or fewer amps in an open-backed rack

Install the ventilation panel above the amps, as shown in the following figure.

Ventilation panel
(attach to the front
or rear of the rack)

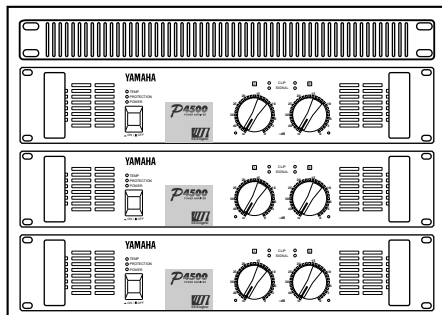

■ Mounting five or more amps, or when (even with four or fewer units) the back of the rack cannot be left open

Install ventilation panels above and below each amp, as shown in the following figure.

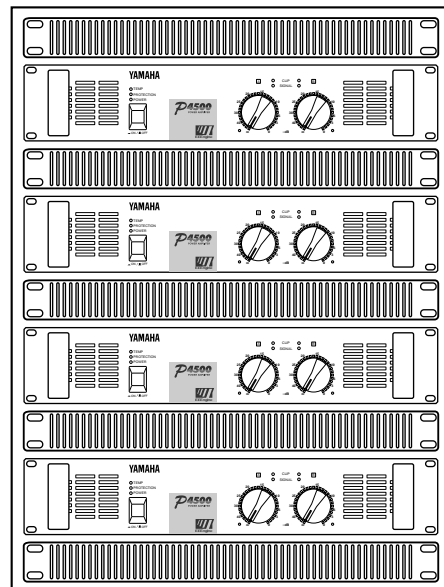

■ Portable Rack Mounting

The amplifier intakes cool air through the front panel and exhausts warm air out the rear panel. When mounting amplifiers in a portable rack, make sure the rear panel is completely open for ventilation.

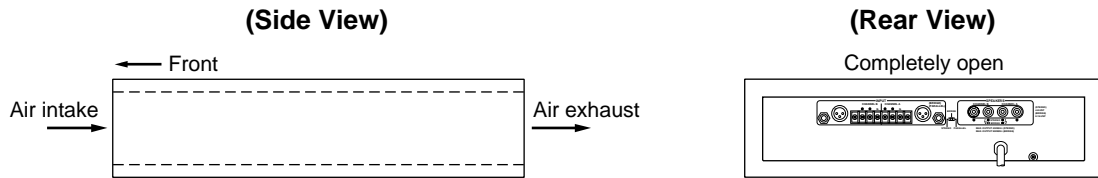

■ Positioning the Housed Amplifier

Place the case so that the ventilation airflow paths are not blocked.

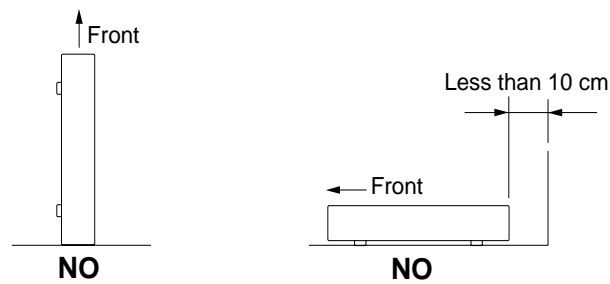

Specifications

■ General Specifications

		P4500	P3200	P1600
Power Output Level (Rated Power) 20 Hz~20 kHz 0.05%	8Ω/STEREO	460 W + 460 W	340 W + 340 W	160 W + 160 W
	4Ω/STEREO	620 W + 620 W	440 W + 440 W	200 W + 200 W
	8Ω/BRIDGE	1240 W	880 W	400 W
1 kHz 0.05%	8Ω/STEREO	520 W + 520 W	370 W + 370 W	175 W + 175 W
	4Ω/STEREO	720 W + 720 W	520 W + 520 W	230 W + 230 W
	8Ω/BRIDGE	1440 W	1040 W	460 W
1 kHz, 20 ms, no clip	2Ω/STEREO	1300 W + 1300 W	950 W + 950 W	350 W + 350 W
Power Bandwidth	Half Power, 0.1%	10 Hz~40 kHz		
Total Harmonic Distortion (THD + N) 20 Hz~20 kHz, Half Power	4~8Ω/STEREO 8Ω/BRIDGE	0.05%		
Frequency Response		10 Hz~50 kHz, +0, -1 dB		
Intermodulation distortion (IMD) 7 kHz: 60 Hz, 1: 4, Half Power	4~8Ω/STEREO 8Ω/BRIDGE	0.05%		
Damping factor	1 kHz, 8Ω	200		
Input Impedance		30 kΩ/Balance, 15 kΩ/Unbalanced		
Residual Noise Vol. min.	12.7 kHz LPF IHF-A network	-80 dB		
SN Ratio Input 600Ω shunt	12.7 kHz LPF IHF-A network	105 dB	104 dB	101 dB
Channel Separation	Half Power, 8Ω, Vol. max. input 600Ω shunt	65 dB, 20 Hz~20 kHz 75 dB, 1 kHz		
Slew Rate 8Ω full swing	STEREO BRIDGE	>30 V/μ sec >50 V/μ sec		
Sensitivity (Vol. max.) Rated Power into 8Ω		+5.7 dB	+4.2 dB	+1.2 dB
Voltage Gain (Vol. max.)		32.1 dB		
Controls	Front Panel Rear Panel	POWER switch (Push on/Push off) Volume (31 position dB calibrated) Mode switch (STEREO/BRIDGE/PARALLEL)		
Connectors	Input Output	Barrier strip terminal XLR-3-31 type 1/4-inch phone jack (balanced) 5-way binding posts		
Indicators	POWER TEMP PROTECTION (mute) CLIP OUTPUT SIGNAL	(heatsink temp ≥ 85°C) × 2 × 2		
Protection Circuits		POWER switch ON/OFF, Muting, DC detection TEMP (heatsink temp ≥ 95°C)		
PC limiter		RL ≤ 1Ω		
Fan Circuits		Low speed (50°C), Variable, High speed (70°C)		
Power Requirements	United States & Canada Europe Other	120 V, 60 Hz 230 V, 50 Hz 240 V, 50 Hz		
Power Consumption		500 W/650 VA	400 W/500 VA	200 W/250 VA
Dimensions (W × H × D)		480 × 103.5 × 455 mm		
Weight		16 kg	15 kg	12 kg
Accessories		Security cover		
Options		Ventilation panel: VP1		

0 dB=0.775 Vrms, Half Power=1/2 Power Output Level (Rated Power)
Specifications subject to change without notice.

■ Block Diagram

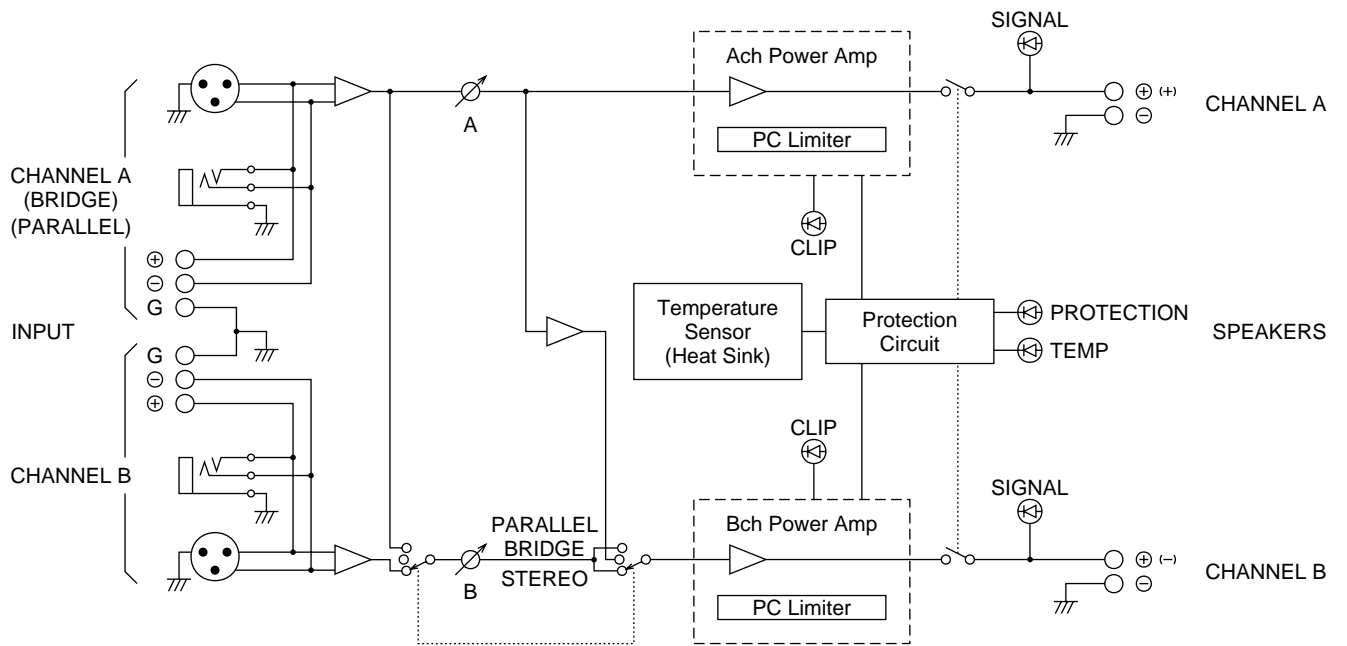

■ Dimensions

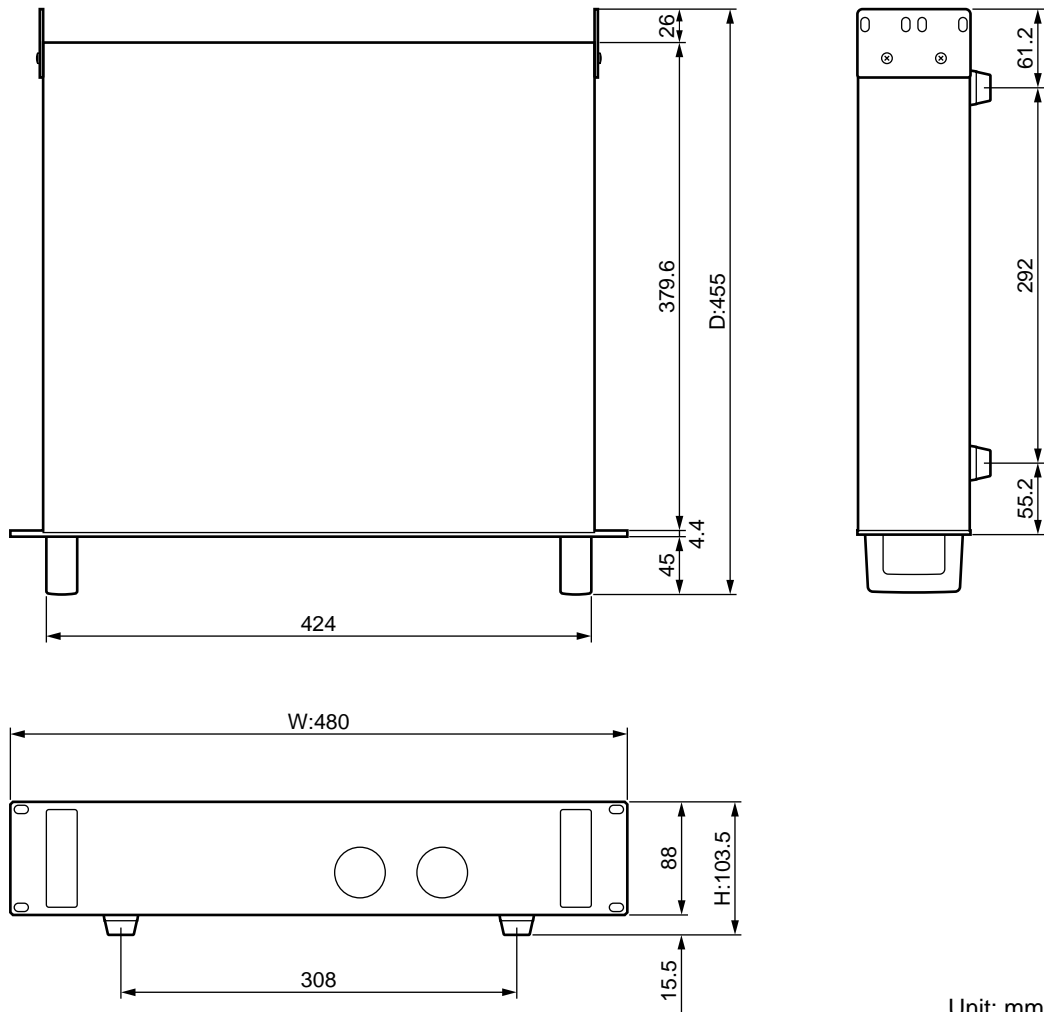

Unit: mm

■ Performance Graphs

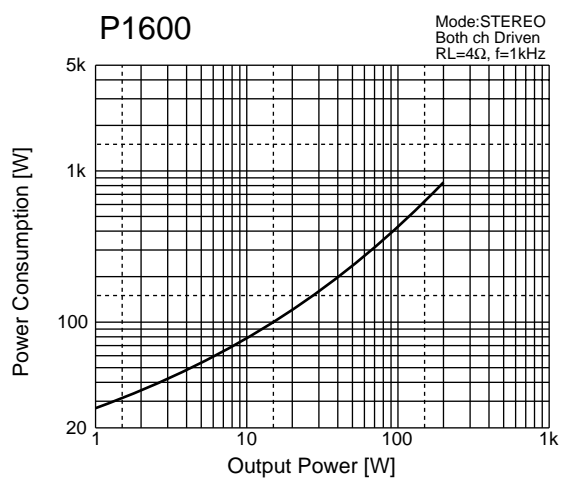
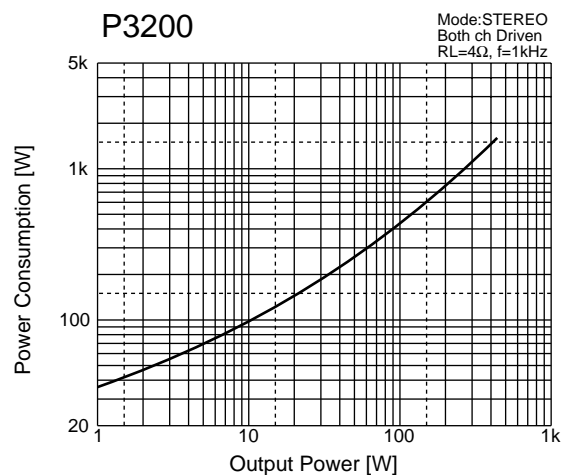
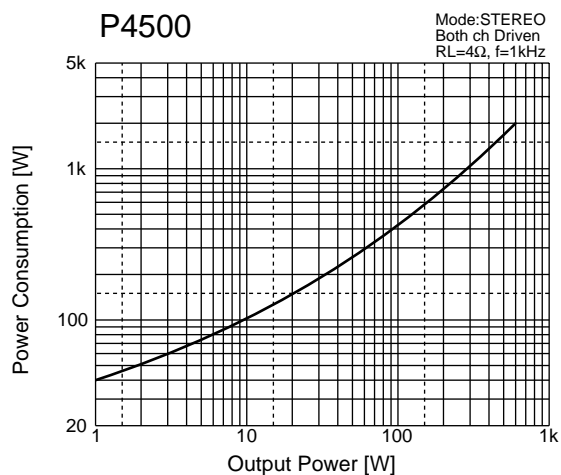

Troubleshooting

The following table lists the main causes of abnormal operation and the corrective measures required, as well as the protective circuit operation in each case.

Indicator	Probable Cause	Remedy	Protection Circuit
CLIP indicator lights.	There is a short at a speaker terminal, amplifier terminal, or wire.	Locate and correct the cause of the short.	The PC limiter circuit operates to protect the power transistors.
	The amplifier load is excessive.	Use a speaker system with an impedance of at least 4Ω (stereo) or 8Ω (bridge).	
TEMP indicator lights.	The heat sink temperature has exceeded 85°C.	Check the ventilation slots, and improve the airflow around the amplifier.	Warning by the TEMP indicator.
PROTECTION indicator lights.	The heat sink temperature has exceeded 95°C.	Check the amplifier ventilation conditions and take appropriate measures to improve airflow around the amplifier.	The thermal protection circuit operates to protect the power transistors.
	A DC voltage of +/-2 V or greater was generated in the power amplifier's output circuit.	Consult your dealer or nearest Yamaha service center.	The relay operates to protect the speaker system.